

Five in one!

Termate's DBBS supports accept 5 conductor sizes offering you choice and flexibility in a single support.

- Simple assembly accommodates 20, 25, 30 x 10 mm; 20, 25 x 5 mm conductors
- Easy connection to moulded case circuit breakers
- Icw ratings of 25kA/3sec and 50kA/1sec
- Ideal for small distribution boards
- 3 and 4 pole versions
- Cost effective

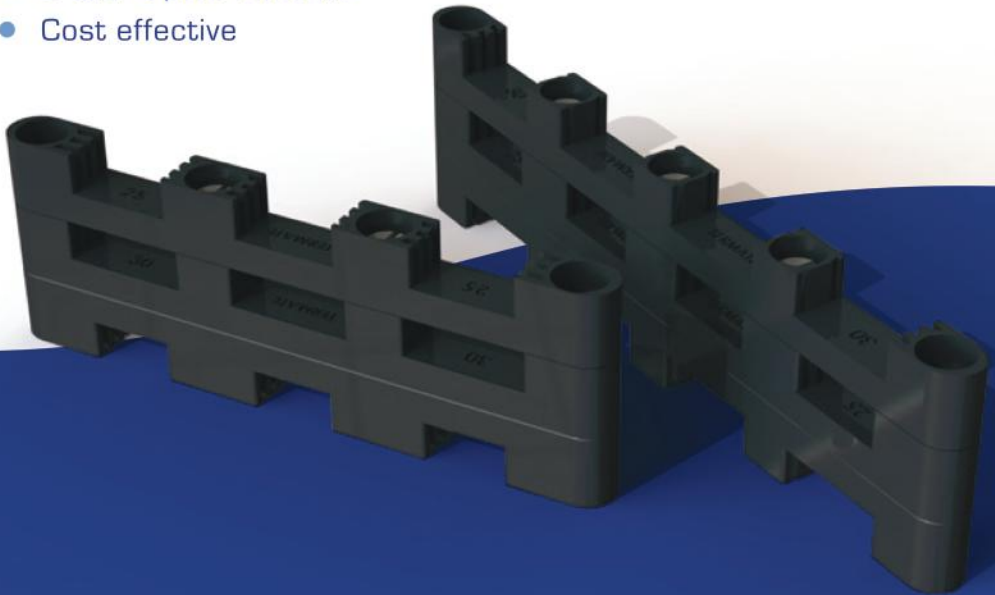

 +44 [0]115 978 4652

 sales@termate.com



TERMATE



TERMATE

Termate have manufactured high performance components since 1956, supplying a global customer base from our U.K. headquarters.

For over 50 years we have independently tested our products to ensure that they meet and exceed the demands of international standards including IEC 61439. We work with leading test houses and certification bodies including kATF, ASTA and Dekra.

Our products offer superb performance and longevity, incorporating materials manufactured to our specification. We listen to our customers requirements and respond, which has led to the introduction of versatile products. These can be used in more applications reducing the total costs to our partners.

We are well known by our customers for the detailed application engineering and the first class customer service we offer.

This leaflet displays our range of DBBS Supports, part of our LV Power Products Range which comprises various types of Busbar Supports, Busplugs, Stand-offs, Through Wall Bushings, and Components for Withdrawable Systems. These products are all manufactured with the latest equipment at our facility in Nottingham.

We hope that our DBBS Supports are of interest. If you would like to receive a quote, application help or learn more about any of our products, we would be delighted to hear from you.

You can find out more information by visiting our website at www.termate.com, alternatively you can email our sales team at sales@termate.com or call **+44 [0]115 978 4652**.

DBBS Busbar Supports

DBBS-3P & DBBS-4P

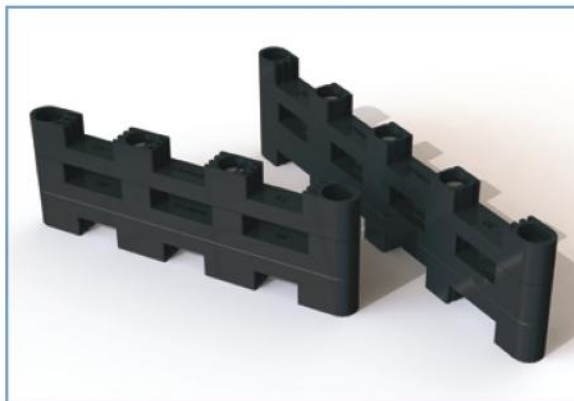

Properties

Material:	Glass Reinforced Polyamide 6.6
Conductor Temp:	140°C†
Flammability:	UL94-V0
Glow Wire:	960°C
Termate Icw Rating (Spacing):	25kA 3s (315 mm) 50kA 1s (220 mm)
Equipment Voltage U _e :	690V
Insulation Voltage U _i :	690V
Impulse Voltage U _{imp} :	6kV

† In line with the limits set out in IEC 61439, insulating components in contact with conductors may be required to continuously operate at an average of 140°C (Max 145°C). This range of products meets the requirement, the material for them being assigned thermal class F established using methods similar to IEC 60085.

Termate is committed to the highest standard of Customer Focus and we have made every effort to maintain the accuracy and completeness of the information provided in this catalogue. Where improvements to our products affect their installation and usage we endeavour to contact any Customers who may be affected.

If you need to rely on our technical data or dimensions in your application, please contact us for further confirmation or detailed dimensional drawings/3D models.

Warranty as stated in Encompass Terms and Conditions of Trading is void if any modification is made to the warranted product.

Key: Colour code for illustration only, supplied parts are all black

20 mm

25 mm

30 mm

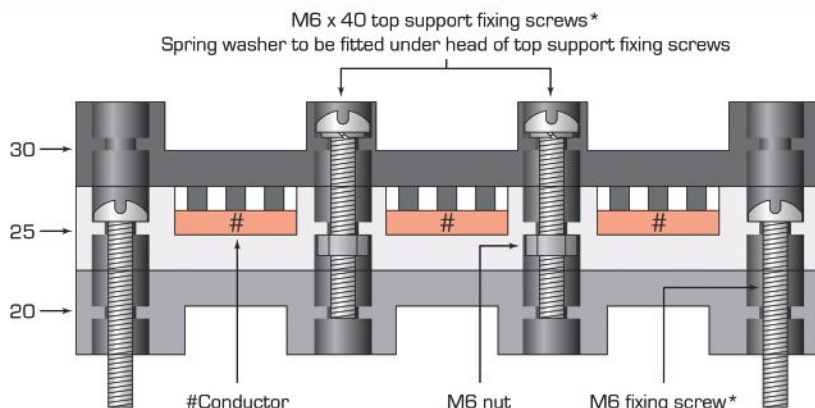
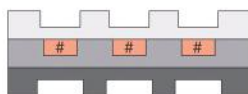
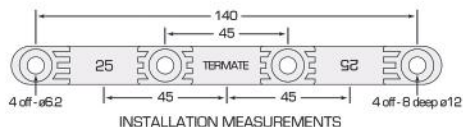
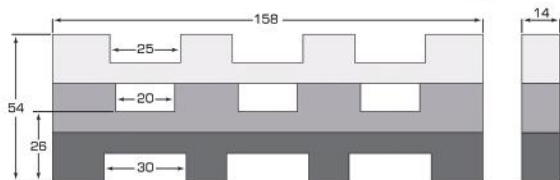

Illustration shows fixing instructions for 3 pole version. For 4 pole version use same fixing instructions with the middle fixing point left empty.

* Recommended tightening torque 5Nm

DBBS-3P Busbar Support



20 x 10 mm #conductor

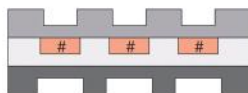

25 x 10 mm #conductor

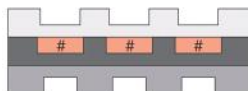

30 x 10 mm #conductor

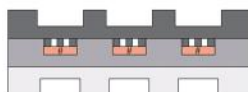

20 x 5 mm #conductor

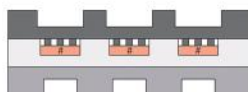

25 x 5 mm #conductor

DBBS-4P Busbar Support

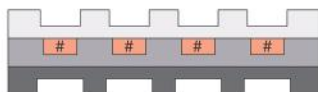
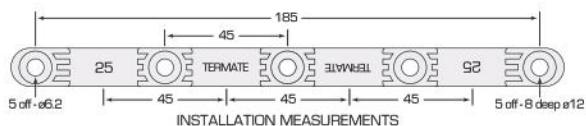
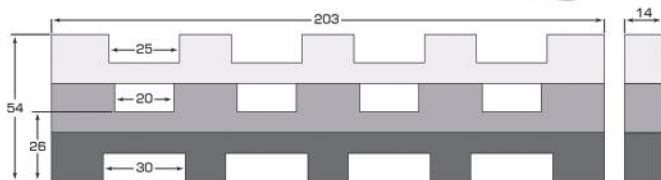

20 x 10 mm #conductor

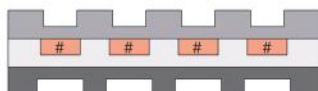

25 x 10 mm #conductor

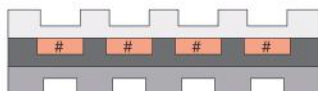

30 x 10 mm #conductor



20 x 5 mm #conductor

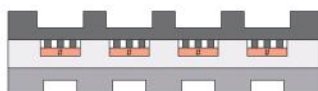

25 x 5 mm #conductor



TERMATE

Termate Limited
John Street
New Basford
Nottingham
NG7 7HL

www.termate.com

 +44 (0)115 978 4652

 sales@termate.com